

HYDRAULIC SIMULATION TABLES

NEXT GENERATION TESTING



Rev.7, May 2018

DESIGNED FOR DURABILITY TESTING
APPLICATIONS REQUIRING HIGH
PERFORMANCE AND RELIABILITY

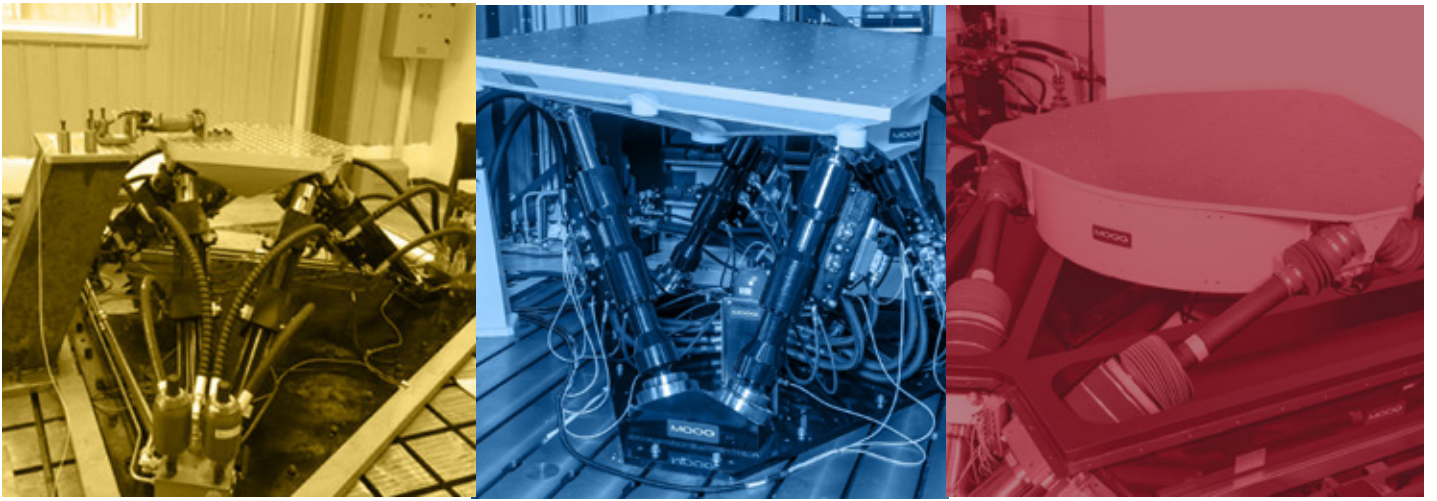

MOOG SIMULATION TABLES SET A NEW STANDARD IN AUTOMOTIVE TESTING

Unsurpassed innovation and technological expertise combined with close customer collaboration make Moog a leader in the design and development of high-performance 6 Degree-of-Freedom (DOF) electric and hydraulic motion platforms. Over the years we have installed more than 1,300 systems.

The proven technology expertise of Moog combined with the world class performance of Moog Actuators, Servo Valves and Digital Controllers deliver long-lasting solutions to meet your challenges today—and tomorrow.

Our total focus on meeting your unique test requirements means you can rest assured you're using the most flexible, highest

performance test equipment available anywhere.

The application of the latest testing techniques has become a cornerstone for creating successful new designs, ensuring shorter vehicle time-to-market, managing increased regulatory pressures and maintaining cost efficiencies.

Wherever test and development engineers are pushing the limits of automotive design, the Moog Simulation Table is an indispensable tool throughout the vehicle development process.

MEETING THE CHALLENGE OF A NEW TESTING GENERATION WITH MAXIMUM VERSATILITY AND STIFFNESS

The hexapod configuration used by Moog Simulation Tables is the optimum design to achieve simulation and test capability using acceleration, force and displacement inputs, and to reproduce data collected on proving grounds regardless of your test type, method or specimen. By understanding today's test trends and challenges, and listening closely to the needs of customers around the world, we developed different types of Hydraulic Simulation Tables for specific applications.

The standard Hydraulic Simulation Table can accommodate loads up to 680 kg (1,500 lb) and frequencies up to 100Hz. The High Frequency Hydraulic Simulation Table is specially designed to reach higher frequencies, up to 200Hz. The Small Hydraulic Simulation Table is designed for smaller and lower weight payloads.



KEY FEATURES TO SUPPORT YOUR TESTING NEEDS

KEY FEATURES

Recommended tests

Vibration, durability, squeak and rattle, noise and harshness.

6 Degree of Freedom motion

Translations: vertical, lateral, and longitudinal
Rotations: pitch, yaw, and roll

Working in synchronization

Six identical actuators performing synchronously for each motion resulting in higher forces and accelerations.

Degree-of-Freedom Control

DOF control allows you to simply put in the frequency and amplitude for a desired direction then the controller and software take over to achieve the expected movement result.

Performance

The industry's most innovative engineering design incorporates proprietary software and digital control, along with the highest quality components to ensure optimal performance.

USER BENEFITS

High performance and versatility

Specific architecture and the exclusion of traditional bell cranks and connecting rods offer greater structural rigidity resulting in higher frequency response / bandwidth.

User-friendly

Minimal moving parts make the Simulation Table quick to install, commission and easy to maintain. The geometry of the assembly of actuators offers a convenient working height for the operator to mount and inspect the test specimen.

Extremely small footprint

Using only one third of the space required by classic systems, this small footprint makes it an integrated solution that is easy to position, run and control anywhere in your test lab.

Maximum flexibility

Accommodates integration of environmental chambers for temperature and humidity testing in connection with vibration testing.

SELECT YOUR HYDRAULIC SIMULATION TABLE

Moog's wide array of technologies and design expertise mean you can choose the Simulation Table that meets your specific performance needs. Our solutions address your specific requirements whether it is higher frequency, payload, footprint, performance, climatic chamber, acoustic chamber, hydrostatic ball joints or fixed based actuator design.

SMALL HYDRAULIC SIMULATION TABLE FOR LOWER MASS

A cost-effective versatile and stiff test system designed for payloads up to 100kg and test frequencies up to 60Hz.

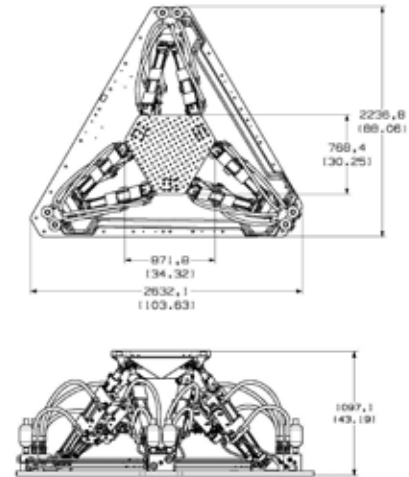

STANDARD SIMULATION TABLE FOR STIFFNESS AND VERSATILITY

Designed for a wide range of test applications that may require up to 100Hz test frequencies at payloads up to 680kg.

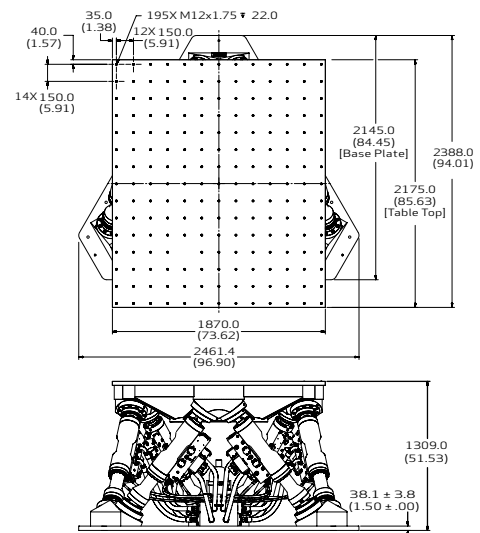

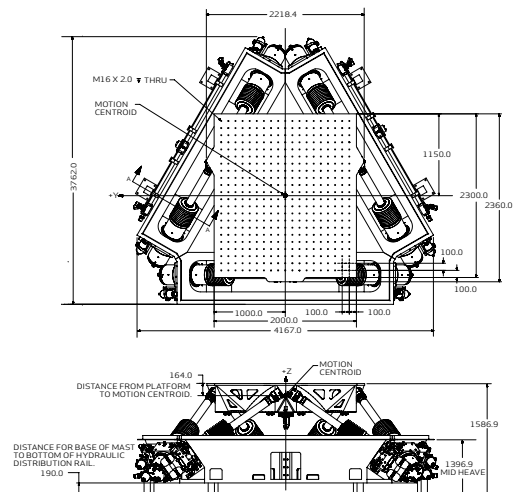

HIGH FREQUENCY SIMULATION TABLE FOR UNIQUE REQUIREMENTS

A special system that achieves full performance at test frequencies up to 200Hz.



SPECIFICATIONS

Depending on the performance, higher payloads are possible.

Model	 Small Simulation Table	 Standard Simulation Table	 High Frequency Simulation Table
System Payload	100 kg (220 lb)	680 kg (1,500 lb)	600 kg (1,322 lb)
Table Mass	120 kg (265 lb)	758 kg (1,670 lb)	742 kg (1,635 lb)
Total Payload (combined)	220 kg (485 lb)	1,440 kg (3,170 lb)	1342 kg (2,950 lb)
Table Size (LxW)	786 x 872 mm (2.6 x 2.9 ft)	2,175 x 1,870 mm (7.1 x 6.1 ft)	2,300 x 2,000 mm (7.5 x 6.6 ft)
Table Mounting Pattern	50 mm (2.0 in)	150 x 150 mm (5.9 x 5.9 in)	200 x 200 mm (8 x 8 in)
Table Mounting Hole Size	M12X1.75	M16	M16
Actuator Peak Force	15 kN (3.4 kip)	54 kN (12.2 kip)	53 kN (12 kip)
Frequency	60 Hz	100 Hz	200 Hz
Excursion			
(Z) Heave (Vertical)	+69.9/ -71.2 mm (2.8 in)	±122 mm (4.8 in)	+163/ -140 mm (6.4/ -5.5 in)
(Y) Lateral	+73.5/ -74.1 mm (2.9 in)	±174 mm (6.9 in)	± 103 mm (4 in)
(X) Longitudinal	+74.2/ -73.9 mm (2.9 in)	+216/ -177 mm (+8.5/ -7.0 in)	±118 mm (4.66 in)
Roll	±13.6 deg (0.24 rad)	±9 deg (0.16 rad)	±7.6 deg (0.13 rad)
Pitch	±12.3 deg (0.21 rad)	±8.5 deg (0.15 rad)	+7.2/ -8.4 deg (0.13/ -0.15 rad)
Yaw	±12.4 deg (0.22 rad)	±12 deg (0.21 rad)	±5.3 deg (0.09 rad)
Velocity			
(Z) Heave (Vertical)	±2.3 m/sec (91 in/sec)	±1.65 m/sec (65 in/sec)	±1,753 m/sec (69 in/sec)
(Y) Lateral	±2.2 m/sec (86.6 in/sec)	±1.62 m/sec (64 in/sec)	±1,218 m/sec (48 in/sec)
(X) Longitudinal	±2.4 m/sec (94.5 in/sec)	±1.65 m/sec (65 in/sec)	±1,405 m/sec (55 in/sec)
Roll	±411 deg/sec (7.2 rad/sec)	±120 deg/sec (2.09 rad/sec)	±95.6 deg/sec (1.67 rad/sec)
Pitch	±409 deg/sec (7.1 rad/sec)	±119 deg/sec (2.08 rad/sec)	±88.9 deg/sec (1.55 rad/sec)
Yaw	±417 deg/sec (7.3 rad/sec)	±145 deg/sec (2.53 rad/sec)	±62.5 deg/sec (1.09 rad/sec)
Acceleration			
(Z) Heave (Vertical)	±158 mm/sec ² (16.1 g)	±108 mm/sec ² (11 g)	+109/ -89 mm/sec ² (+11.1/ -9.9 g)
(Y) Lateral	±104 mm/sec ² (10.6 g)	±64 mm/sec ² (6.6 g)	±64 mm/sec ² (6.5 g)
(X) Longitudinal	±101 mm/sec ² (10.3 g)	±57 mm/sec ² (5.8 g)	±80 mm/sec ² (8.2 g)
Roll	±23,000 deg/sec ² (400 rad/sec ²)	±10,000 deg/sec ² (174 rad/sec)	±4,000 deg/sec ² (73 rad/sec)
Pitch	±26,000 deg/sec ² (450 rad/sec ²)	±8,500 deg/sec ² (148 rad/sec)	+4,000/ -5,000 deg/sec ² (73/ -90 rad/sec)
Yaw	±31,000 deg/sec ² (540 rad/sec ²)	±7,500 deg/sec ² (131 rad/sec)	±8,900 deg/sec ² (155 rad/sec)

This technical data is based on current available information and is subject to change at any time by Moog. All numbers have been abbreviated to improve readability. Specifications for specific systems or applications may vary. e.g. High Frequency Hydraulic Simulation Table static excursions in lateral displacement minimum ±110mm; longitudinal displacement minimum ±120mm; Yaw angle minimum ±5.5°.

FRAUNHOFER LBF USES MOOG HIGH FREQUENCY HYDRAULIC SIMULATION TABLE FOR VEHICLE COMPONENT AND BATTERY TESTING

Moog supplied to Fraunhofer LBF, German Institute for Structural Durability and System Reliability Research, a complete test system to be integrated with a climatic chamber and battery-testing safety system. The test system consists of a Moog High Frequency Hydraulic Simulation Table and real-time controller, including Moog operator test and application software.

The test system is rated for frequencies up to 200 Hz and will aid Fraunhofer LBF in the evaluation of electric car battery performance in order to assist the automotive industry with research and development for batteries

and electric vehicles. During testing, the batteries will undergo drive simulation and vibration tests to measure the performance and durability aspects under 'real' circumstances. A virtual model will simulate power consumption and measure the charge and discharge of the batteries during a car ride. All power consuming car parts will be included in the test, such as the electric motor, power steering, wipers, windows, lights, audio, heating, etc.

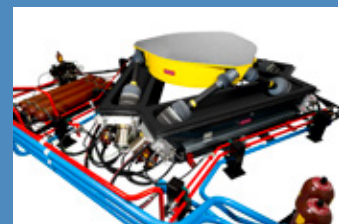

MOOG TEST CONTROLLER

The Moog Test Controller is a 1 to 32 channel real-time modular control system that can control or collect data from any hydraulic or electric test system. The robust and compact modules have a wide range of transducer inputs and control outputs that can be easily configured for optimum use. The Moog test software allows the end user to control and record all of these signals in an easy to use format providing maximum value for many years of reliable usage.



FEATURES	BENEFITS
Familiar feature-rich software: configurable hardware bindings, wizard for calibration, powerful control loops	No new training for current users; new users will appreciate the simplified interfaces that allow complex tasks with minimal training
Easier 1 piece modules	With less parts to manage, moving hardware between controllers is safe
Easier upgrades in future with CPU module and Manifold Control Unit	Modular design permits low cost upgrades to take advantage of rapidly improving technology or controller expansion
Higher density I/O per module	Lower cost per connection with more I/O packed into less space
Flexible I/O - Configurable Digital Input, Digital Output, Analog Input or Accelerometer (ICP)	One connection can be used to serve different functions giving you no added cost options as your test needs change
1 to 32 channel expansion easier	Low cost controller expansion with space saving channel or data acquisition modules avoiding expensive racks with limited slots
Better 24-bit signal resolution	32 times improvement in signal resolution over 19-bit, giving better precision to control or recorded data

THULE TWISTS AND TURNS WITH THE MOOG SIMULATION TABLE

Moog helped Thule, the world's leading supplier of automotive rack systems, make their systems even more reliable with a complete test system featuring a hydraulic simulation table.

"We have been very successful with the test system," said Eric Gustavsson, Thule Test Manager. "It is compact, fast and has a simple iteration process. We use it very intensively, running it constantly, 24 hours per day. We can create different types of tests. If a customer—for example, a car manufacturer—requests a test on a Thule roof rack with specific specifications, we can save the data and share it with him. We may go as far as recreating real-life situations on a file. Every car has different characteristics

and therefore requires a different test. For example, we can specify the road type and general conditions (weather), the tire pressure and type of tire, and how the car moves. Based on that information we make the test suitable for a specific customer."



SOFTWARE TO MEET YOUR NEEDS

The Moog Test Controller includes the Moog Integrated Test Suite as the core to operating complex tasks in easy-to-use ways. Complementing the iNtegrated Test Suite software are several optional application packages to expand control, capability and test performance.



CONTROL YOUR TEST WITH THE MOOG INTEGRATED TEST SUITE

Configure, calibrate and tune equipment with easy-to-use setup screens and then build and play simple to complex test sequences for durability tests.

Key Features	User Benefits
<p>Supports multiple test systems</p> <ul style="list-style-type: none"> Single and multi-axis hydraulic or electric test systems, Hydraulic Simulation Tables, Electric Simulation Tables, Tire Coupled Simulation Systems 	<p>One controller platform for many uses</p> <ul style="list-style-type: none"> User interface includes configuration, calibration, tuning and test players for strength, fatigue or vibration tests
<p>Integrated suite</p> <ul style="list-style-type: none"> Utilize a variety of functions for simple or complex tasks 	<p>User friendly and intuitive</p> <ul style="list-style-type: none"> One learning curve for operating different test rigs Supports less experienced operators or total control for advanced users High value software without hidden extras Additional capability with optional application software
<p>Real time motion control</p> <ul style="list-style-type: none"> Multiple control loops, amplitude and phase matching, bumpless control switching, data acquisition 	<p>Test accuracy and efficiency</p> <ul style="list-style-type: none"> Optimal control and data recording across all channels minimizes setup and run time
<p>Maximum access to configurable hardware</p> <ul style="list-style-type: none"> Bind the high density I/O needed to the test station, easily calibrate sensors 	<p>Cost effective hardware and software combination</p> <ul style="list-style-type: none"> High utilization of available I/O Quick setup leads to more testing uptime
<p>Customize your user interface</p> <ul style="list-style-type: none"> Multi-language support (9 languages including English, German, and Chinese) Save/load user interface layouts (scopes/meters) User authentication (levels of access) 	<p>Efficient localization</p> <ul style="list-style-type: none"> Preferred language Time saving monitor sets Control access to key information
<p>Several players built-in to run your test</p> <ul style="list-style-type: none"> Cycle player- multi-axis phased operation with target matching and recording Sequence player- create custom tests with ramp, cycle, drive file instructions, recordings and/or triggered actions 	<p>One software package to run simple or advanced tests</p> <ul style="list-style-type: none"> One user interface to run and monitor simple fatigue tests, or monitor complex tests with nested instructions, data recording, and dozens of triggered actions

COMPONENTS TO ENSURE BEST PRECISION

Each Moog Simulation Table incorporates world class performance of Moog components . Every element of the Simulation Table is thoughtfully integrated in the engineering design to offer unsurpassed performance, reliability and longevity.

SERVO VALVES

Moog Hydraulic Simulation Tables incorporate our well known Servo Valves (one per actuator). Moog Servo Valves are known for their exact tolerances, high performance and durability. They are the preferred choice of leading test engineers and set the world standard for hydraulic Servo Valve performance.



TEST ACTUATORS

Our Hydraulic Simulation Tables use six hydrostatic or polymer bearing actuators. They are engineered to deliver consistent performance over hundreds of millions of cycles. They provide increased reliability, stiffness and increased side load capabilities. They have a robust design which offers low maintenance due to improved seal life, and improved cushion design (improved energy dissipation).

Moog has vast experience developing actuators for some of the world's most demanding applications and building high performance motion control components is one of our strengths. Actuators are key to high performance test solutions and our customers have expressed a need for more reliable, high performance components than they can find in the marketplace.

Hydrostatic Bearing Test Actuator

- Used in the Standard Hydraulic Simulation Table
- Innovative 8 pocket hydrostatic bearing increases side load capacity to 60% of stall output and reduces energy requirements
- Higher level of dynamic performance, reliability, and longevity
- Advanced coating used on the rod significantly improves seal wear for long life and less maintenance
- Fully integrated manifold eliminates the need for any external piping



Polymer Bearing Test Actuator:

- Used in the Hydraulic Simulation Table 100kg
- Oil-cooled polymer bearing improves side load capacity to 15% of stall output, compared to 10% with traditional polymer bearing design
- Advanced cushion design for higher reliability and safety
- Higher level of dynamic performance, reliability, and longevity
- Advanced coating used on the rod significantly improves seal wear for long life and less maintenance
- No external piping

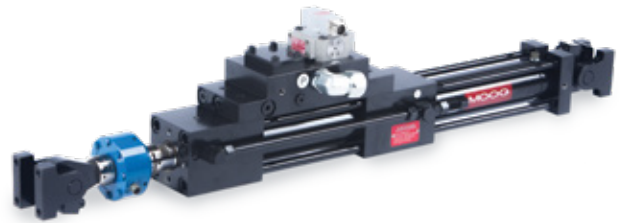

BALL JOINTS

Actuator joints ensure the smoothest possible movement and significant angular displacement via a spherical ball swivel joint on each actuator end. These ball joints are designed to allow large angular displacement with maximum stiffness and zero backlash.

Ball joint design

A "superbolt" or "multi-jackbolt tensioner" is used as a direct hex nut replacement. They spin onto your existing stud and provide an improved way to assemble the joint, as they are used to tighten the joint in pure tension. Ordinary hand tools are used to tighten.



HYDRAULIC INTERFACES

TEST DISTRIBUTION MANIFOLD

The Test Distribution Manifold is fully integrated into the Simulation Table assembly and creates an optimum configuration for the layout of the hoses to the actuators. Optional items can be connected to this Test Distribution Manifold for convenience and flexibility.

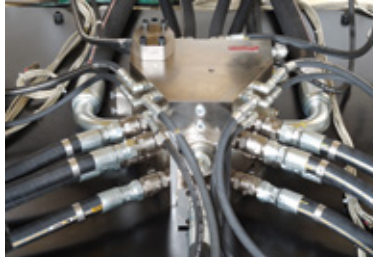

TEST SERVICE MANIFOLD

The Test Service Manifold used on the Simulation Table is capable of a peak flow of 1,140 lpm (300 gpm) at 210 bar (3,000 psi). It contains a 3 micron filter in the pilot line, and 25 micron filters for the pressure line. Accumulators installed in the Pilot, Return and Supply lines serve to dampen unwanted pulsations. Control valves are used to control pressure and flow to ensure the system meets all safety requirements.



Hydraulic Distribution System	
Oil Requirements	
System Fluid	Mobil DTE-25, Shell Tellus 46, or equivalent
System Fluid	Mobil DTE-24, Shell Tellus 32, or equivalent
Filtration Requirements	
To prolong the operational life of active hydraulic components, the hydraulic fluid should be maintained at a cleanliness level of ISO 4406 (SAE J1165) 16/14/11 (NAS 5) or better.	
Pressure	
Operating Pressure	210 bar (3,000 psi) and/or 280 bar (5,000 psi) for the High Frequency Hydraulic Simulation Table
Maximum Return Pressure	14 bar (200 psi)
Maximum Drain Pressure	3.5 bar (50 psi)
Operating Temperature	
Hydraulic oil temperature should be maintained between 24 °C (75 °F) and 57 °C (135 °F)	

MOOG HYDRAULIC SIMULATION TABLE ALLOWS EXOVA TO ACHIEVE MORE REALISTIC AUTOMOTIVE TESTING

Steve Panter, operation manager of global automotive testing provider Exova, purchased the standard Moog Hydraulic Simulation Table and states, "A lot of damage occurs within the range from 50 to 80 Hz when a company does testing analysis. With a lower performance simulation table, results are often filtered down to 40 Hz, so any damaging events beyond that point are not captured." Panter adds, "The Moog Hydraulic Simulation Table allows those events to be included in the scope of testing, and broadens the value of the testing process." The Moog Hydraulic Simulation Table gives users a

frequency of response up to 100 Hz and can handle payloads up to 680 kg (1,500 lbs).



MOOG ELECTRIC SIMULATION TABLES

Performance testing

The Moog family of Simulation Table solutions includes Hydraulic and Electric options. Our Hydraulic Simulation Tables provide solutions for structural and durability testing and our Electric Simulation Tables provide solutions for performance testing. Depending on the application a certain configuration can be proposed. Below examples of test applications can be found.

Ride and Comfort Test System

6 DOF ride and comfort test system



Driving Simulator with lateral rail

7 DOF driving simulator with lateral rail for vehicle dynamics research or advanced driver assistance.

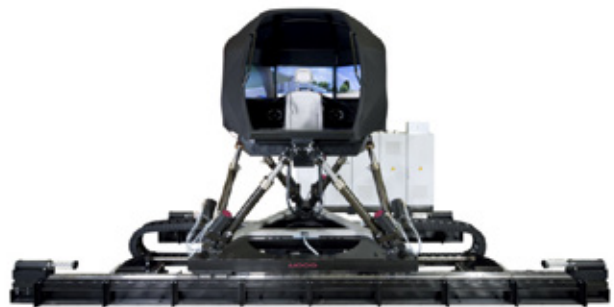

Tank Turret Test System

6 DOF tank turret test system with pneumatic assist, capable of handling payloads up to 23 tons.

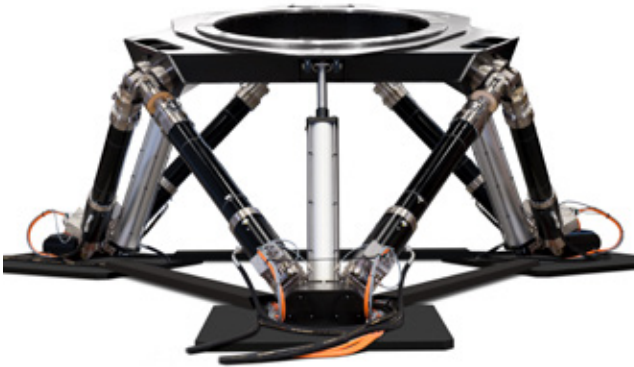

Fuel Tank Test System

6 DOF Electric Simulation Table with 2-DOF Tilt Table.



Driving Simulator with yaw table

7 DOF motion base with yaw table to simulate city driving.

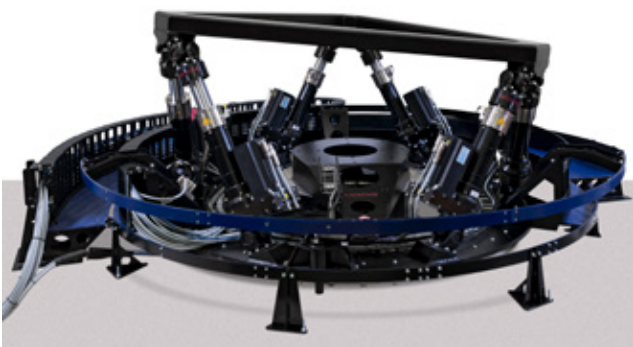

Antenna Test System

6 DOF antenna test system

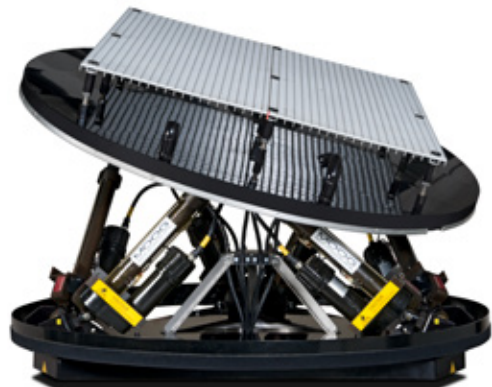

SERVICE AND SUPPORT

Five Point Inspection Process

Our number one goal is to eliminate downtime and make repairs that will deliver reliability and cost savings for years to come. When you send in your repair, it must work like new when you get it back. This is the Moog Global Support® promise.

- Incoming inspection will provide the customer details on the performance of the assembly. For actuators it could be leakage or response. For electronic modules it could be a non-functional connection. The inspection will also provide details to our technicians in regards to critical performance specs that need to be addressed.
- Technicians will then review engineering notes for any design improvements that may have been initiated since inception.
- Servo valves are removed and sent through the same rigorous evaluation, disassembly and test.
- Finally, the individual component or assembly will be tested to original specs to ensure the overhauled unit meets all design and performance criteria as if it were new.

Moog Engineering On Call For You

In today's competitive manufacturing environment, machine performance plays a significant role in determining your bottom line. Moog Global Support is key to achieving cost-effective machine operation, day in and day out.

We are committed to providing world-class motion control products and solutions, taking customer support far beyond the initial sale. Our dedicated approach solves your problems, addresses your machine challenges, and allows you to achieve maximum productivity on a daily basis.

Repair Capabilities

Moog Global Support® is designed to keep your critical machines up and running at peak performance with only 100% genuine Moog replacement parts. Only Moog replacement parts can deliver the reliability, versatility and long life that you would expect from a world leader in motion control solutions. Each Moog part delivers essential components with precise dimensions, close tolerances and specifications. Because we understand the key role our parts play in the overall operation of your machine, we carefully inspect and test each repair to identify only those components that need replacement.

The Moog Difference

It's time you worked with a partner who can offer both the world-class products you desire and collaborative expertise you need to reach the next level of performance. Contact us today to see the difference Moog can make.



TAKE A CLOSER LOOK.

Moog designs a range of products that complement the performance of those featured in this catalog. Visit our website for more information or contact the Moog facility nearest you.

Australia
+61 3 9561 6044
info.australia@moog.com

Ireland
+353 21 451 9000
info.ireland@moog.com

South Africa
+27 12 653 6768
info.southafrica@moog.com

Brazil
+55 11 3572 0400
info.brazil@moog.com

Italy
+39 0332 421 111
info.italy@moog.com

Spain
+34 902 133 240
info.spain@moog.com

Canada
+1 716 652 2000
info.canada@moog.com

Japan
+81 46 355 3767
info.japan@moog.com

Sweden
+46 31 680 060
info.sweden@moog.com

China
+86 21 2893 1600
info.china@moog.com

Korea
+82 31 764 6711
info.korea@moog.com

Turkey
+90 216 663 6020
info.turkey@moog.com

France
+33 1 4560 7000
info.france@moog.com

Luxembourg
+352 40 46 401
info.luxembourg@moog.com

United Kingdom
+44 168 485 8000
info.uk@moog.com

Germany
+49 7031 622 0
info.germany@moog.com

The Netherlands
+31 252 462 000
test@moog.com

USA
+1 716 652 2000
info.usa@moog.com

Hong Kong
+852 2 635 3200
info.hongkong@moog.com

Russia
+7 8 31 713 1811
info.russia@moog.com

India
+91 80 4057 6666
info.india@moog.com

Singapore
+65 677 36238
info.singapore@moog.com

www.moog.com/industrial

Moog is a registered trademark of Moog Inc. and its subsidiaries. All trademarks as indicated herein are the property of Moog Inc. and its subsidiaries.
©2018 Moog Inc. All rights reserved. All changes are reserved.

Hydraulic Simulation Table
MSH/PDF/Rev.7, May2018, Id. CDL28939-en